

TEHNIČKI LIST

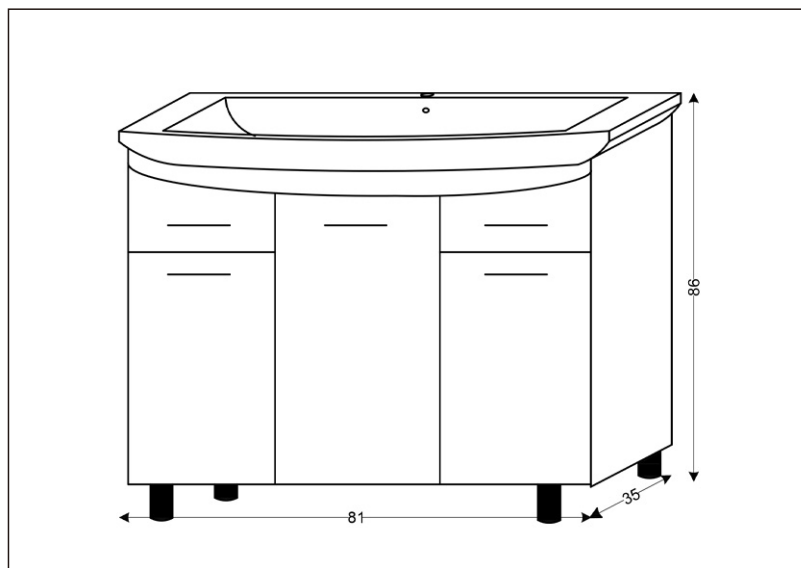

Seriya: **VEGAS**

Šifra proizvoda: **26500036**

TEHNIČKI PODACI

Težina: 51,250Kg

Materijal: Medijapan

Dimenzije: 81x86x35cm

Proizvođač: Ralkom ZTR Kremić Rajko PR

Zemlja proizvodnje: Srbija