

TEHNIČKI LIST

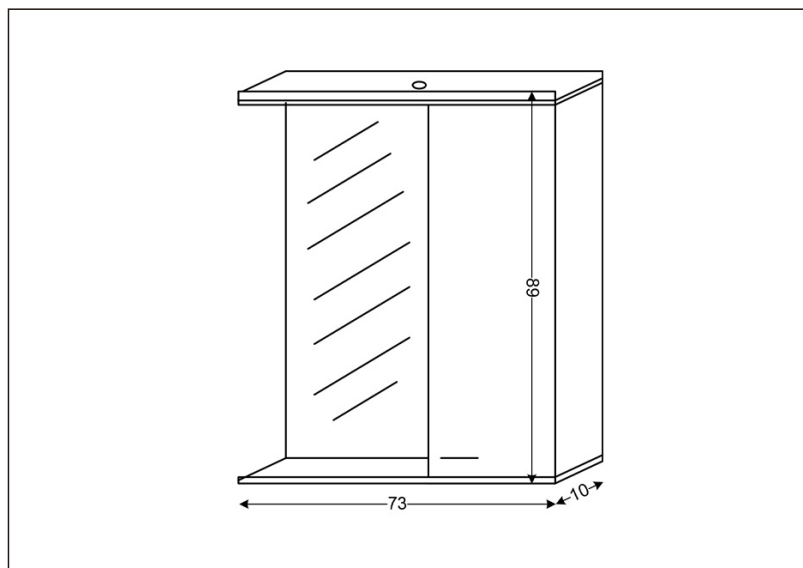

Seriya: **VEGAS**

Šifra proizvoda: **26500040**

TEHNIČKI PODACI

Težina: 19,000Kg

Materijal: Medijapan

Dimenzije: 73x89x10cm

Proizvođač: Ralkom ZTR Kremić Rajko PR

Zemlja proizvodnje: Srbija