

# TEHNIČKI LIST

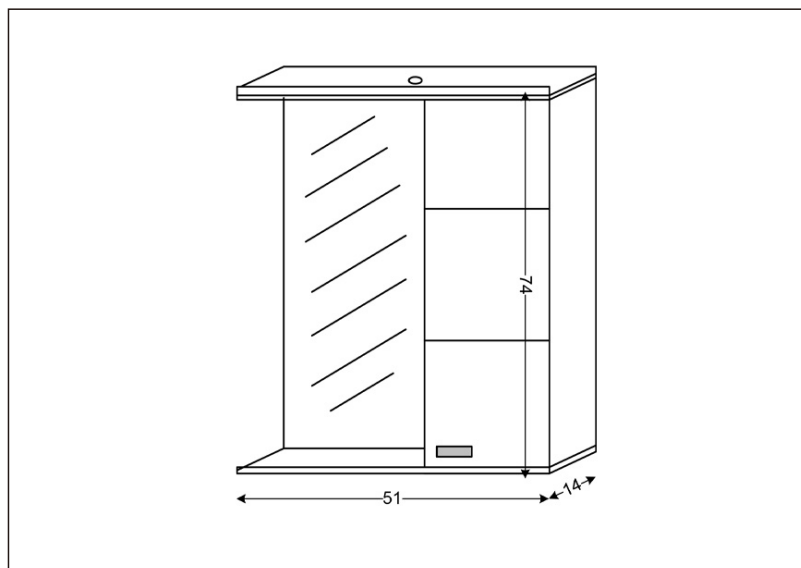

Seriya: **VIENNA**

Šifra proizvoda: **26500090**

## TEHNIČKI PODACI

Težina: 10,350Kg

Materijal: Medijapan

Dimenzije: 51x74x14cm

Proizvođač: Stojković Keramika d.o.o.

Zemlja proizvodnje: Srbija