

TEHNIČKI LIST

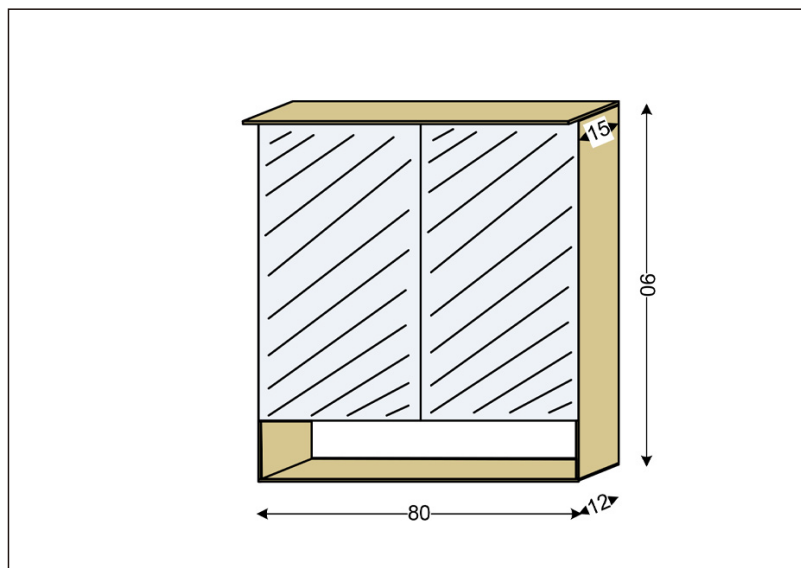

Seriya: **PARIS**

Šifra proizvoda: **26500106**

TEHNIČKI PODACI

Težina: 20,300Kg

Materijal: Medijapan

Dimenzije: 80x90x12cm

Proizvođač: Ralkom ZTR Kremić Rajko PR

Zemlja proizvodnje: Srbija