

TEHNIČKI LIST

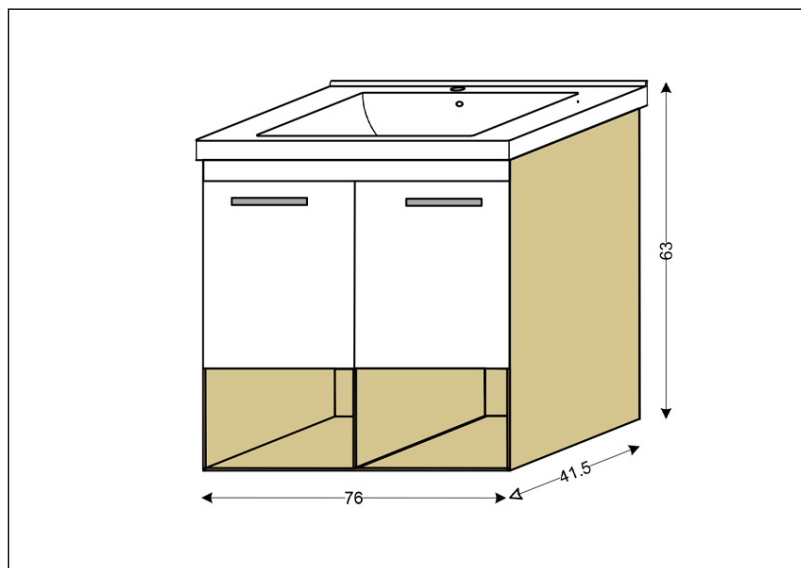

Seriya: **PARIS**

Šifra proizvoda: **26500115**

TEHNIČKI PODACI

Težina: 43,000Kg

Materijal: Medijapan

Dimenzije: 76x63x41,5cm

Proizvođač: Ralkom ZTR Kremić Rajko PR

Zemlja proizvodnje: Srbija