

TEHNIČKI LIST

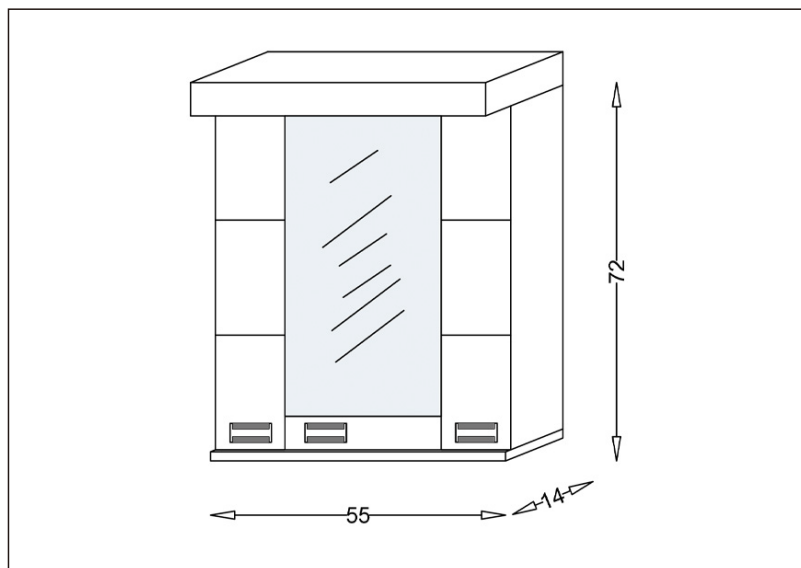

Seriya: **VIENNA**

Šifra proizvoda: **26500123**

TEHNIČKI PODACI

Težina: 13,000Kg

Materijal: Medijapan

Dimenzije: 55x72x14cm

Proizvođač: Stojković Keramika d.o.o.

Zemlja proizvodnje: Srbija