

# TEHNIČKI LIST

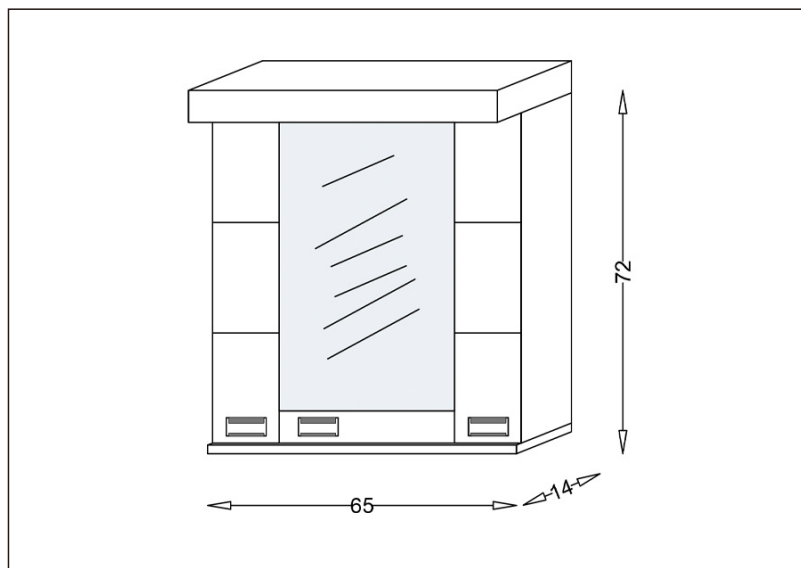

Seriya: **VIENNA**

Šifra proizvoda: **26500124**

## TEHNIČKI PODACI

Težina: 16,000Kg

Materijal: Medijapan

Dimenzije: 65x72x14cm

Proizvođač: Stojković Keramika d.o.o.

Zemlja proizvodnje: Srbija